

EDU INTERNAL BATTERY REMOVAL

FALCON SERVICE BULLETIN

FALCON 900EX EASy

FALCON 900LX

FALCON 900DX

No 614

December 18, 2023

MANDATORY

ATA 46

INFORMATION SYSTEMS

ELECTRONIC FLIGHT BAG SYSTEM

EDU INTERNAL BATTERY REMOVAL

© 2023 - Dassault Aviation

All rights reserved.

FALCON 900EX**F900EX - 614**

INFORMATION SYSTEMS
ELECTRONIC FLIGHT BAG SYSTEM
EDU INTERNAL BATTERY REMOVAL

Initial_Issuance

September 15, 2023

List of effective pages : 1 to 7

Erratum

December 18, 2023

REASON: Modification of BIOS zip file CRC32 calculation.

1. PLANNING INFORMATION**A. EFFECTIVITY**

This Service Bulletin is applicable to:

- F900EX aircraft with serial numbers 97, 120 thru 600 (F900EX EASy, F900LX),
- F900EX aircraft with serial numbers 601 thru 624 (F900DX),

equipped with CMA-1310 Electronic Display Unit (EDU) P/N 100-604073-000 with at least MOD2.

B. REASON

The CMA-1310 EDU has experienced failures related to swelling of the lithium-polymer batteries. Such a swelling may cause damage to the unit touchscreen and/or LCD assembly enclosure and may also make it difficult to dock the unit.

Swelling is due to stress conditions caused by high inrush charge and discharge current applied on a deeply discharged lithium-polymer battery.

The purpose of this Service Bulletin is to prevent external removable battery swelling by removing the internal battery and by updating the BIOS firmware to improve the Lithium-polymer charging algorithm of the CMA-1310 EDU.

C. DESCRIPTION

For LH and/or RH EDU (**L7101NS**)/(**R7101NS**), the operation consists in:

- removing the internal battery,
- updating the BIOS of the CMA-1310 EDU.

D. COMPLIANCE

Mandatory as prescribed by the Airworthiness Authorities of the country of registration of the aircraft.

Recommended to be performed during the next "12 M or 800 FH" inspection, unless otherwise specified by an Airworthiness Directive issued by the country of registration of the aircraft.

E. APPROVAL

This Service Bulletin covers DASSAULT AVIATION modification FALCON F900EX M-OPT485 that has been approved under the authority of the DOA ref. EASA.21J.051.

The technical content of this document is approved under the authority of the DOA ref. EASA.21J.051.

F. LABOR

Estimated labor-hours: Refer to Service Bulletin Commercial Summary.

NOTE: These labor-hours only concern the work described in this Service Bulletin and do not include other maintenance work that may be performed on this occasion.

G. MATERIAL - PRICE AND AVAILABILITY

Price and availability on request.

H. TOOLING

- TOOL BOX (**TO-20-008**).

I. WEIGHT AND BALANCE

Change in weight: None.

Change in balance with respect to 25% MAC: None.

J. REFERENCES

Aircraft Maintenance Manual:

- GENERAL MAINTENANCE AND SAFETY PRECAUTIONS (**TASK 20-00-00-910-801**)

- USE OF THE AIRCRAFT MAINTENANCE PROCEDURES ([TASK 20-00-00-910-803](#))
- ENERGIZATION / DE-ENERGIZATION OF THE AIRCRAFT SYSTEMS ([TASK 24-00-00-860-801](#))

K. OTHER PUBLICATIONS AFFECTED

None.

2. ACCOMPLISHMENT INSTRUCTIONS

NOTE: The following operations are to be performed on LH and/or RH EDU (([L7101NS](#))/([R7101NS](#))).

A. GENERAL INSTRUCTIONS AND SAFETY PRECAUTIONS

- (1) Obey the general maintenance and safety precautions ([TASK 20-00-00-910-801](#)).
- (2) Check the external removable battery for integrity (no swelling). If swelling is noticed, replace the battery :
 - Press the two clips ([1-fig. 1](#)) to unlock the battery ([2-fig. 1](#)).

CAUTION: MAKE THE REMOVED BATTERY UNSERVICEABLE.

- Remove the battery ([2-fig. 1](#)).
 - Install a new battery ([2-fig. 1](#)) in position.
 - Make sure that the clips ([1-fig. 1](#)) are engaged.
- (3) Get a software that can calculate CRC32 checksum (for example "7-zip File Manager").

B. PRELIMINARY STEPS

- (1) The aircraft must be in the maintenance configuration ([TASK 20-00-00-910-803](#)).
- (2) Contact commandcenter@dassault-aviation.com or commandcenter@dassaultfalconjet.com to get the BIOS firmware password.
- (3) Download the CMA-1310 AMI BIOS V134 (File name: IBCMC.V134.SHELL.zip) software from the Falcon Portal to a USB key (refer to [3.B.](#)).
- (4) Proceed to BIOS zip file CRC32 calculation (for example with "7-zip" previously got) ([fig. 2](#)) as follows:
 - If the "7-Zip / CRC SHA" functionality is available, perform the following steps:
 - right click on the ".zip" file, the "CRC SHA" menu, and then the "CRC-32" option ([1-fig. 2](#)),
 - check that the "CRC-32" value is "560244EA".
 - If the "7-Zip / CRC SHA" functionality is not available, perform the following steps:
 - right click on the ".zip" file, then select "Send to a compressed folder" option ([2-fig. 2](#)),
 - select "Yes" to create the .zip file on the desktop,
 - right click to open the .zip file on the desktop,
 - if necessary, right click in the explorer header to activate the "CRC-32" option ([3-fig. 2](#)),
 - check that the "CRC-32" value is "560244EA".

- (5) Remove the EDU from its support.

NOTE: The following steps should be done out of the cockpit area to facilitate the operation.

C. PROCEDURE

- (1) According to CMC Electronics Vendor Service Bulletin pilotview-46-64 attached:

CAUTION: MAKE THE REMOVED BATTERY UNSERVICEABLE.

- remove the internal battery,
- update the BIOS.



D. FINAL STEPS

- (1) In the cockpit, install the EDU on its support.
- (2) Energize the aircraft systems ([TASK 24-00-00-860-801](#)).
- (3) On the EDU, make sure that the FalconSphere II Home page is displayed.
- (4) Make sure that the aircraft type and registration ID match the aircraft.
- (5) De-energize the aircraft systems ([TASK 24-00-00-860-801](#)).

E. RECORDING

Record compliance with this Service Bulletin in the appropriate aircraft documents.

Fill out the electronic Service Bulletin reply form accessible from the "Service Bulletin" page on the Falcon portal or register SB implementation at Sbconfiguration@dassault-aviation.com, providing all useful information for aircraft identification:

- aircraft type and serial number,
- SB compliance: complete or section(s) applied,
- remarks,
- compliance date,
- service center.

3. MATERIAL INFORMATION

NOTE: Compliance with this Service Bulletin by substituting the part numbers below with interchangeable subsequent part numbers (as per DASSAULT-approved supply list) is acceptable, provided that subsequent part numbers have the same effectivity as the original ones.

A. MODIFICATION OF EDU PART NUMBER

NEW P/N	QTY	KEY WORD	OLD P/N
100-604073-000 MOD7	1 or 2	LH EDU (L7101NS) and/or RH EDU (R7101NS)	100-604073-000 MOD 2 or MOD3 or MOD4 or MOD5 or MOD6

B. SOFTWARE

Effectivity: All aircraft

P/N	FILE NAME	KEY WORD	SUPPLIER
185-616980-009wr	IBCMC.V134.SHELL.zip	CMA-1310 AMI BIOS V134	DASSAULT AVIATION through FALCON PORTAL

C. LOCAL PROCUREMENT

- USB key
- USB keyboard (QWERTY)
- USB mouse

FALCON 900EX**F900EX - 614**

- USB hub
- **isopropyl alcohol** (TT-I-735 A)
- **loctite 242**
- X-Acto knife with ceramic blade (or equivalent)
- Watchmaker screwdriver
- External removable battery P/N 205-601017-000 in case of replacement

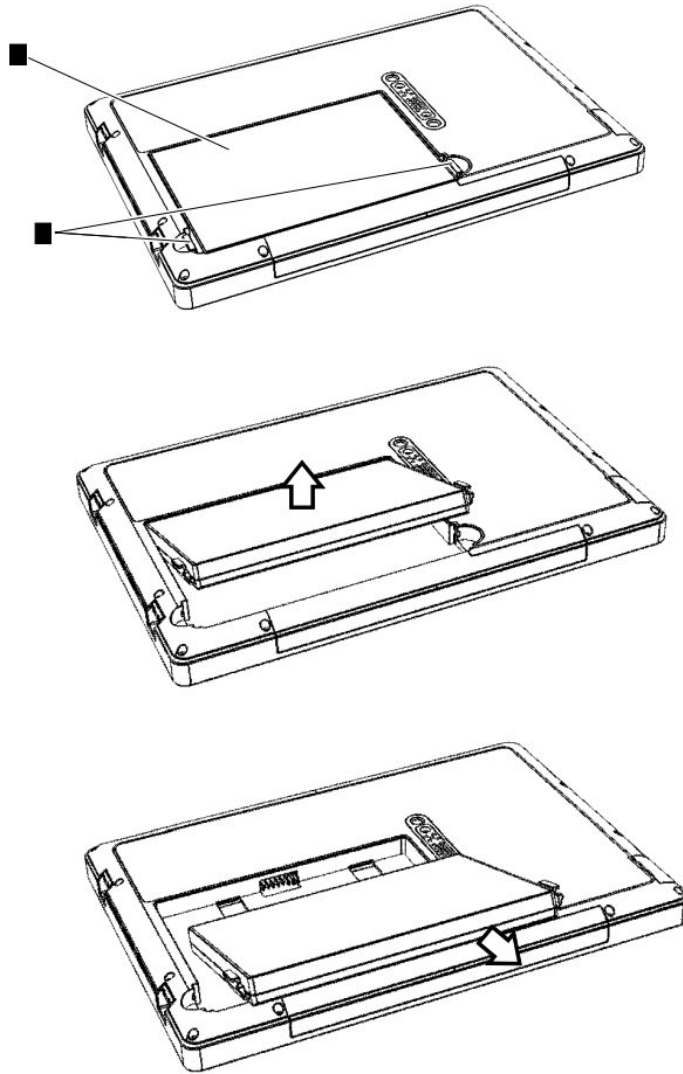

Figure 1: EXTERNAL REMOVABLE BATTERY REPLACEMENT

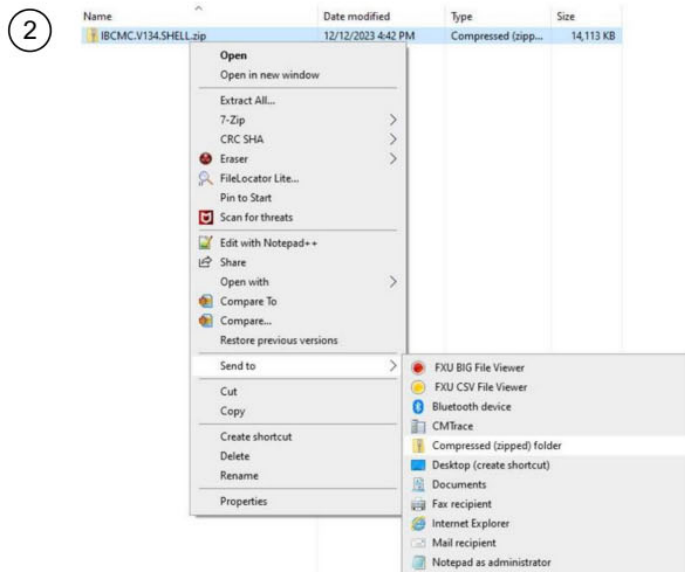
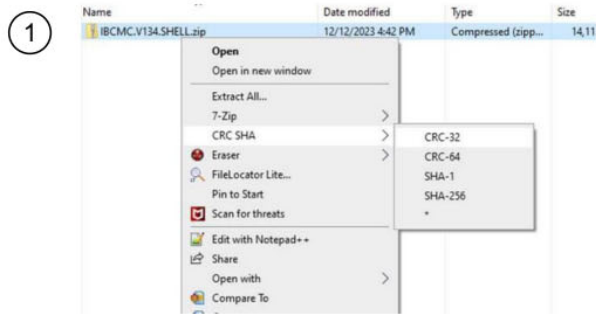

Figure 2: BIOS CHECKSUM CALCULATION

See the figure content in appendix
Figure 3: PILOTVIEW-46-64

Appendix

Vendor Service Bulletin



CAGE CODE 90073

CMC Electronics
600 Dr. Frederik Philips Boulevard
Ville Saint-Laurent (Quebec) Canada, H4M 2S9
Tel.: 514-748-3148 Fax: 514-748-3014 <http://www.cmcelectronics.ca>

INFORMATION SYSTEMS CMA-1310 PILOTVIEW® ELECTRONIC DISPLAY UNIT (EDU) BIOS / EMBEDDED CONTROLLER (EC) FIRMWARE UPDATE (MOD 7)

1. PLANNING INFORMATION

A. Effectivity

CAUTION: DO NOT USE OR OPERATE THE CMA-1310 PILOTVIEW® EDU WITH A SWOLLEN BATTERY: REMOVE ANY SWOLLEN BATTERIES AS SOON AS THE CONDITION IS DETECTED. DISPOSE OF THE LITHIUM BATTERY IN ACCORDANCE WITH LOCAL REGULATIONS. CONTACT CMC PRODUCT SUPPORT FOR OPTIONS TO REPLACE A SWOLLEN BATTERY UNDER THE TERMS OF THE APPLICABLE WARRANTY OR SERVICE CONTRACT. DEVIATING FROM THIS RECOMMENDATION MAY PRESENT A RISK OF THERMAL RUNAWAY.

This Service Bulletin affects the following equipment:

Table 1 - Equipment affected

Equipment	Part Number	Current MOD Status	New MOD Status
CMA-1310 PilotView® EDU	100-604073-000	MOD 2 at minimum	MOD 7

B. Concurrent requirements

Service Bulletin PILOTVIEW-46-49 (MOD 2) must be accomplished before the implementation of this SB.

C. Reason

The CMA-1310 PilotView® EDU has experienced infant mortality failures related to the swelling of the lithium-polymer batteries: this swelling may induces damages to the units touchscreen and/or LCD assembly enclosure and may also cause difficulties in docking the unit. The swelling is due to a high inrush charge and discharge current stress condition applied on a deeply discharged lithium-polymer battery.

August 04, 2023

This proprietary document and all information contained therein is the property of CMC Electronics Inc. It may not be used, copied, reproduced or otherwise dealt with, nor may its contents be communicated to others in whole or in part, without the express written consent of CMC Electronics Inc. It may not be used directly or indirectly for purposes other than those expressly granted in writing by CMC Electronics Inc. pilotview-46-64 Rev. 3
Page 1 of 28

The root cause resides in the charging algorithm implemented through the CMA-1310 PilotView® EDU BIOS / EC firmware.

D. Description

The purpose of this Service Bulletin is to provides instructions to:

1. Update the EDU BIOS / EC firmware (CMC P/N 169-616980-009) on the units specified in the [Planning section A.](#) section to improve the Lithium-polymer charging algorithm of the CMA-1310 PilotView® EDU.
2. Remove the internal battery (CMC P/N 205-601019-000).

E. Compliance

The implementation of this Service Bulletin is mandatory and must be implemented at the earliest opportunity from the reception. As long as the Service Bulletin is not implemented, the units must not be used in battery mode to avoid any recharging of their batteries.

F. Approval

This Service Bulletin contains no modification information that revises the approved configuration. The technical content of this Service Bulletin is approved under the authority of DOA nr. EASA.21J.051.

G. Manpower

The customer may perform this Service Bulletin. The estimated time required to complete this Service Bulletin is approximately 1.5 hour.

H. Weight and Balance

Not changed.

I. Electrical Load Data

Not changed.

J. Software Accomplishment Summary

Not applicable.

K. References

ECO #20424

L. Other Publications Affected

CMA-1310 Operators Manual (CMC Part No. 930-600208-000).

M. Other

Not applicable.

August 04, 2023

This proprietary document and all information contained therein is the property of CMC Electronics Inc. It may not be used, copied, reproduced or otherwise dealt with, nor may its contents be communicated to others in whole or in part, without the express written consent of CMC Electronics Inc. It may not be used directly or indirectly for purposes other than those expressly granted in writing by CMC Electronics Inc.

pilotview-46-64 Rev. 3

Page 2 of 28

2. MATERIAL INFORMATION

A. Tooling

There are no special tools, fixtures or equipment necessary for this SB.

B. Material Required

Table 2 - Material Required

ITEM NO	NAME	QTY	REFERENCE
1	Load for the CMA-1310 AMI BIOS V134 (CMC P/N 185-616980-009wr) (Checksum: 0x560244EA)	1	185-616980-009wr (V90073; CMC to deliver electronically)
2	USB Flash Drive	1	Commercially available
3	Isopropyl Alcohol	1	TT-I-735 Commercially available
4	X-Acto Knife w/ ceramic blade	1	Commercially available
5	Sealing Locking & Retaining Compound, 242	1	822-990038-736 (V90073) 242, V05972
6	Aircraft Mount Unit (AMU)	1	100-604075-000 (V90073)
7	USB Keyboard	1	Logitech Model K-120, (V46628) or equivalent Commercially available

C. Material Discarded

Table 3 - Material Discarded

ITEM NO	NAME	QTY	REFERENCE
1	Battery Pack, 400MAH, 7.4V, Lithium Ion	1	205-601019-000 (V90073)
2	Label, Battery, Lithium	1	624-601990-019 (V90073)

3. ACCOMPLISHMENT INSTRUCTIONS

A. General

This section provides the accomplishment instructions to remove the internal battery and to install new BIOS / EC firmware on the CMA-1310 PilotView® EDU.

CAUTION: ALL REPAIRS SHALL BE MADE BY AUTHORIZED AND QUALIFIED PERSONNEL. FAILURE TO OBEY THIS SAFETY PRECAUTION MAY RESULT IN DAMAGE TO THE EQUIPMENT.

B. Electrostatic Discharge control

This equipment contains components which are sensitive to damage by electrostatic discharge (ESD).

Modules that have components sensitive to ESD are identified on the module by a safety label as follows:



- (1) The equipment must be handled using an ESD workbench, properly grounded, and covered with a soft conductive rubber mat or equivalent. The technician must wear a protective ESD coat and a wrist strap electrically connected to the work bench.
- (2) When replacing or returning the modules for service, the technician should adhere to the following safety precautions:
 - (a) Handle the modules with extreme caution. When picking-up or handling a module do not touch the leads, pins or tracks.
 - (b) Keep each spare module in its electrostatic discharge (ESD) protective packing bag until it will be used.
 - (c) Touch a grounded metallic surface, such as a rack or cabinet, to discharge static electricity before moving or handling a module. A wrist strap grounded through a one Megaohm (M ohm) resistor should be used when handling the modules. (The wrist-strap ground must be the same as the grounded equipment).
 - (d) Do not slide electrostatic-sensitive modules over any surface.
 - (e) Clothing must not come in contact with components or assemblies. Short sleeves garments are preferred; if long sleeves garments are worn then roll up the sleeves
 - (f) Prepare parts correctly for storage or transportation. When removing the modules from the equipment, immediately place each module into ESD-protective packing bag. Do not place papers, cards or plastics inside the ESD-protective packing bag.
 - (g) When preparing the modules for storage or transportation, keep them in their individual ESD-protective bag. Fold over and seal the mouth of the bag to keep out any packing material that can generate static (for example, foamed polystyrene). Carefully place ESD-protective packing material around each bag to prevent motion which can generate statics.

C. Internal Battery Removal Procedure

(1) Removal of the rear cover of the EDU:

(a) On the EDU back side, remove the EDU battery pack as shown:



(b) Unscrew 2x M2x6 screws at the bottom of the EDU (circled in red) as shown:



(c) Unscrew all 10x M2x4 screws on the rear cover as shown:



(d) Unscrew 2x M2x2 screws inside the battery slot as shown:



- (e) Gently separate the rear cover by placing fingers approximately where shown and by applying a firm gentle pressure:



(f) Disconnect the flat cable assembly (remove tape, lift the tab and pull the flat cable). Then completely remove the EDU rear cover as shown:

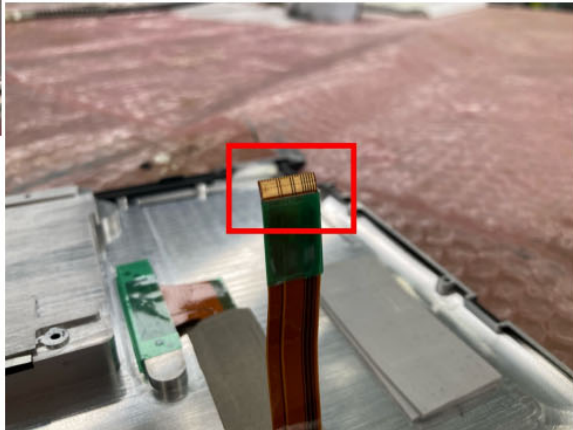
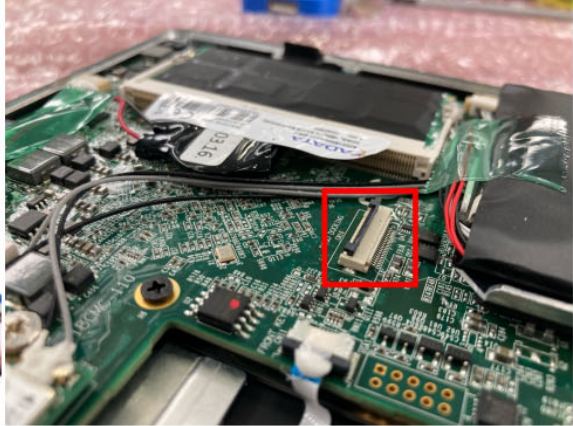

(2) Removal of the Internal Battery Pack.

- (a) Remove the tape on the battery cable and gently remove the adhesive that secures the battery connector in place. Disconnect the battery cable from the connector as shown:

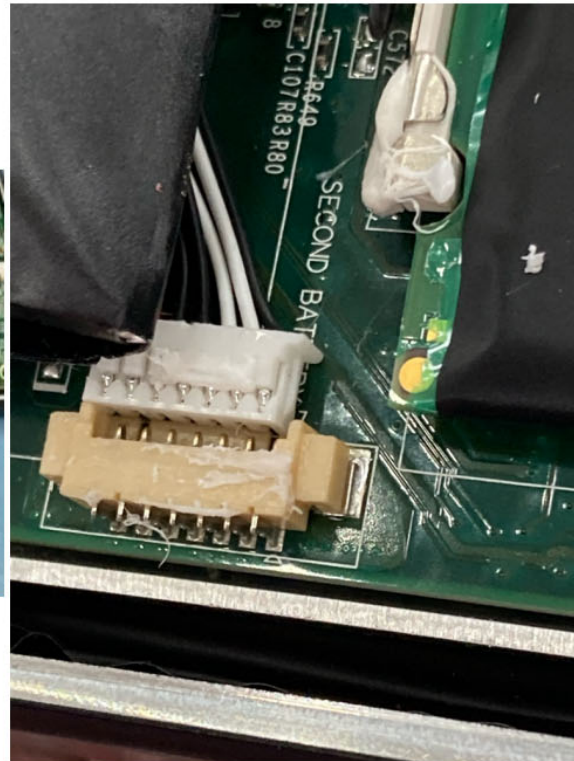
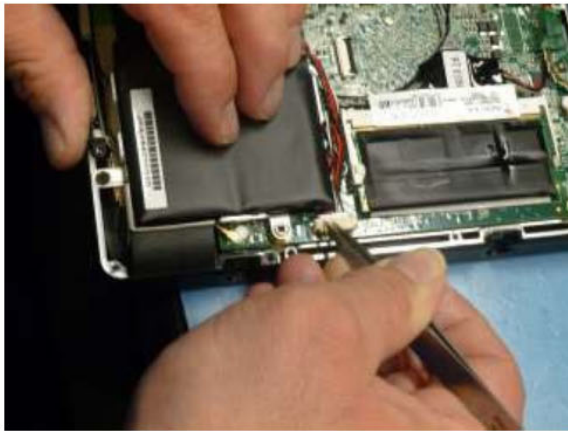

WARNING: EXERCISE CARE WHEN USING KNIFES OR SHARP CUTTING TOOLS NEAR BATTERIES. FAILURE TO OBEY THIS SAFETY PRECAUTION MAY TRIGGER A BURNING OR EXPLODING BATTERY CONDITION AND RESULT IN INJURY TO PERSONNEL AND/OR DAMAGE TO THE EQUIPMENT.

- (b) Gently remove the internal battery using the X-Acto (4, [Table 2](#)) tool dipped in Isopropyl Alcohol (3, [Table 2](#)) as shown:

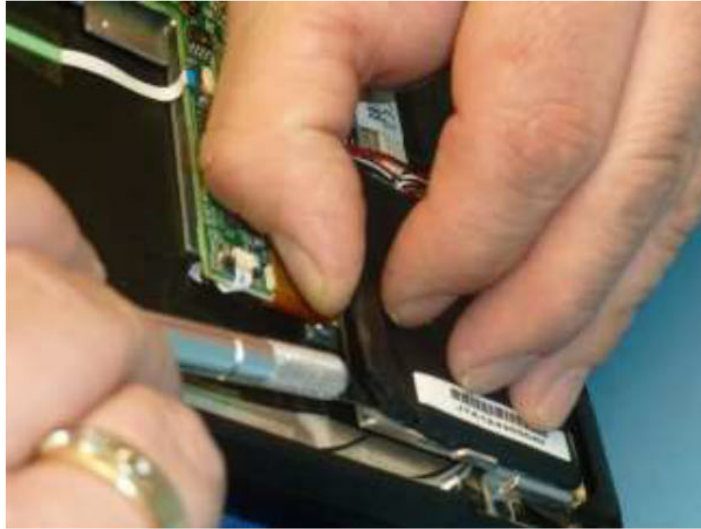

- (c) Remove the coarse residue adhesive that secured the battery using the X-Acto (4, [Table 2](#)) tool as shown. Clean off any fine adhesive residues using a cloth dipped in alcohol.

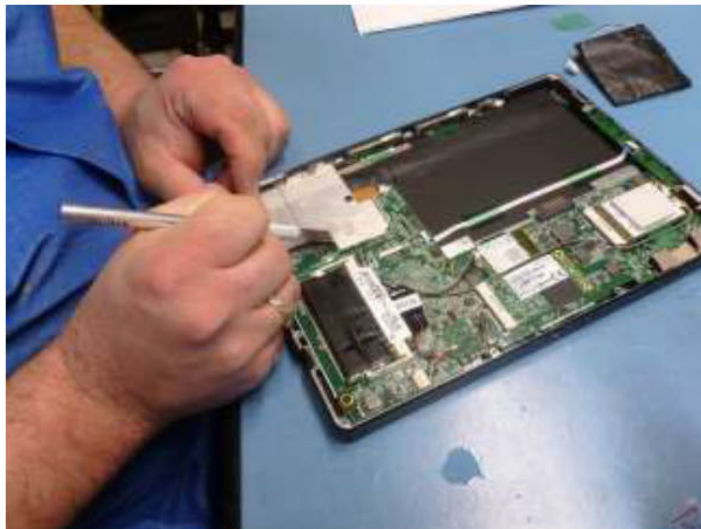

(3) Installation of the rear cover of the EDU.

(a) Connect the flat cable connector to the main board connector, close the tab as shown and use Kapton tape to secure in place.

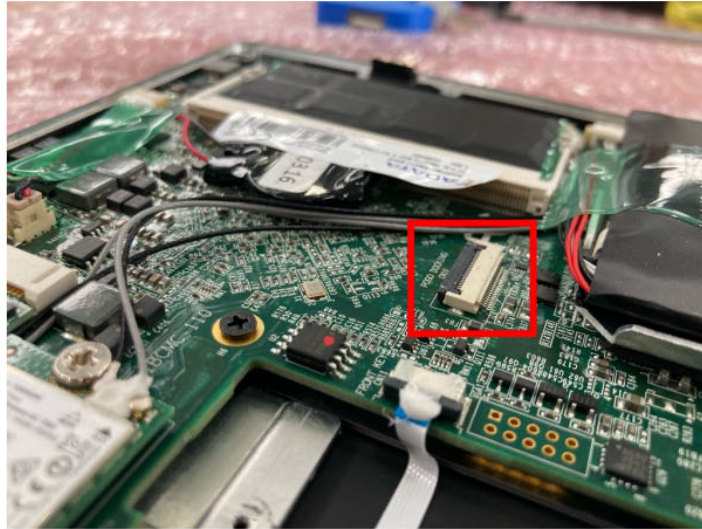

(b) Close the EDU rear cover as shown:

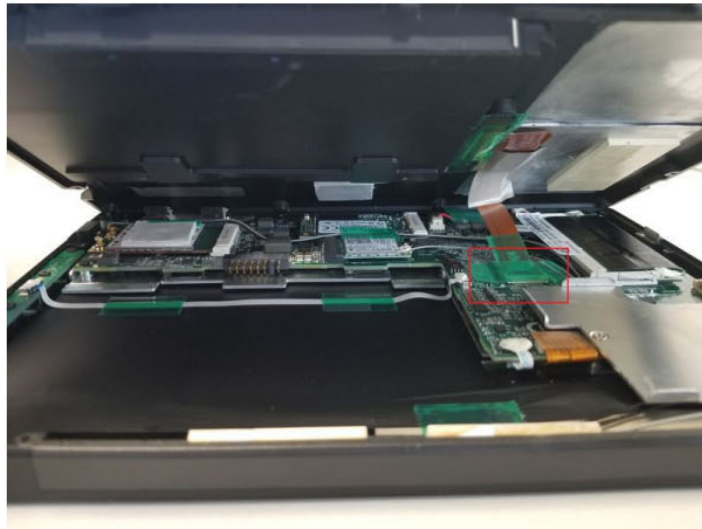

- (c) Install 10x M2x4 screws to re-attach the rear cover to the front cover as shown. Torque to 1.5 in-lbs (0.17 N-m).

NOTE: Apply Loctite (5, [Table 2](#)) on the screws prior to assembly.



- (d) Install 2x M2x2 screws at the battery slot location as shown. Torque to 1.5 in-lbs (0.17 N-m).

NOTE: Apply Loctite (5, [Table 2](#)) on the screws prior to assembly.



- (e) Install 2x M2x6 screws to lock the rear cover to the front cover as shown. Torque to 1.5 in-lbs (0.17 N-m).

NOTE: Apply Loctite (5, [Table 2](#)) on the screws prior to assembly.



- (f) Remove the Lithium Battery Label (2, [Table 3](#)) using the X-Acto (4, [Table 2](#)) tool as shown. Clean off any adhesive residues using a cloth dipped in alcohol.



(g) Re-install the removable battery pack as shown:



D. BIOS / EC Firmware Update Procedure

- (1) To update the BIOS/EC Firmware to CMC P/N 169-616980-009: follow the instructions in [Appendix A](#). Refer to item 1, [Table 2](#), for required ZIP file.
 - In [Appendix A](#), under the "Update/Flash BIOS and EC under UEFI Shell mode" section, use the following commands to navigate through directories:
 - In section 5, only consider the drive called "fs"
 - In section 7, use
 - `ls` to list the files of a directory
 - `cd` to change directory
 - `cd ..` to revert to the parent directory
 - Use the help command to see the command syntax, ex: `help cd`
- (2) After the update, follow instructions in [Appendix A](#). under Section "Reload Serial Number under UEFI Shell Mode" to reprogram the original unit serial number.

E. Validation Procedure

(1) SCOPE

This validation procedure establishes the tests required to ensure that the unit modified AS per this Service Bulletin is operational. The unit is deemed in a serviceable condition when all tests passed successfully.

(2) PROCEDURE

(a) Power and BIOS tests

1. Install the EDU on the powered AMU (6, [Table 2](#)) (ensure that a USB Keyboard (7, [Table 2](#)) is connected to the side of the EDU).
2. Verify that the Blue LED turns on for 5 seconds while the EDU turns on automatically.
3. Press the DEL key on the keyboard. When prompted, enter the BIOS password to enter the BIOS Setup Menu.
4. Verify that the Project Version is IBCMCV134 x64
5. Verify that the EC Version is IBCMP134
6. Press and hold the power button for 1 second, and verify that the unit is shutting down.

(b) Touch Screen Response test

1. With the stylus, touch the screen surface (4 corners and center position).
2. Verify that the touchscreen operates properly.

(c) Time and Date test

1. Verify that the current date and time is accurate.

(d) Battery test

1. Observe the Battery Indicator icon on the Task Bar.
2. Verify that the "Plugged In" icon is shown:



3. Remove the EDU from the AMU.
4. Verify the "Running On Battery" icon is shown:



F. Recording of the Modification

- (1) Scratch MOD 7 on the CMA-1310 PilotView® EDU MOD Plate.

NOTE: The MOD Plate is located under the removable battery.

G. CMC Customer Support

Should further technical information about this Service Bulletin be required, please contact CMC Technical Support.

CMC TECHNICAL SUPPORT

- North America 1-888-827-2881
- Worldwide (+1) 514-748-3050

To send a request by email, complete our customer support request form at:

<http://www.cmcelectronics.ca/CustomerSupport/TechnicalSupport.aspx>

BIOS and EC Firmware Update Guide

UEFI Shell Mode

V3.0

Please read these instructions carefully before using this product, and save this manual for future use.
August 04, 2023

This proprietary document and all information contained therein is the property of CMC Electronics Inc. It may not be used, copied, reproduced or otherwise dealt with, nor may its contents be communicated to others in whole or in part, without the express written consent of CMC Electronics Inc. It may not be used directly or indirectly for purposes other than those expressly granted in writing by CMC Electronics Inc.

pilotview-46-64 Rev. 3
Page 17 of 28

Document Number	Revision Number	Description	Author	Revision Date
000001	1.0	Initial release.	Willy Fang	Nov.24 2011
000001	2.0	Modify UEFI shell mode update section.	Willy Fang	Dec.05 2013
000001	2.1	Modify UEFI shell mode device selection section.	Brian Lu	July.25 2014
000001	2.5	Add how to change CSM parameters for bios DOS mode update.	Brian Lu	July.28 2014
000001	2.6	Split UEFI mode to one document	Willy Fang	Sep.22.2014
000001	2.7	Change example to meet M101B	Willy Fang	Sep.23.2014
000001	2.8	Update instruction for clarity	Willy Fang	Apr.22.2015
000001	2.9	Update instruction to add SMBIOS/Serial Number restoring procedure	Willy Fang	Mar.7.2017
000001	3.0	Revised p.2, 5, 6, 7, 9, 10 and 11 description	Young Huang	Apr.23. 2019

BIOS and EC Firmware Update Guide 1

August 04, 2023

This proprietary document and all information contained therein is the property of CMC Electronics Inc. It may not be used, copied, reproduced or otherwise dealt with, nor may its contents be communicated to others in whole or in part, without the express written consent of CMC Electronics Inc. It may not be used directly or indirectly for purposes other than those expressly granted in writing by CMC Electronics Inc.

pilotview-46-64 Rev. 3
Page 18 of 28

BIOS and EC Firmware Update Guide

Introduction

This guide details the required steps to perform updates to BIOS and EC firmware of Winmate tablets.

The update procedure requires user to prepare an USB drive containing BIOS/EC update files first, and then the user will then boot the computer into BIOS UEFI Shell Mode, and perform BIOS and EC firmware update using the update script file prepared in the update USB drive.

Requirements

1. Tablet to be updated
2. An empty USB drive
3. Winmate BIOS Update files
4. USB hub powered with an external AC adapter (**Note:** if the USB Hub is not externally AC powered, the BIOS and EC firmware update run the risk of being corrupted.)
5. USB QWERTY keyboard
6. Another Windows PC to prepare update USB drive

Preparing USB Drive with BIOS/EC FW Update Files

1. Plug in an empty USB drive to a PC and format it to FAT32.

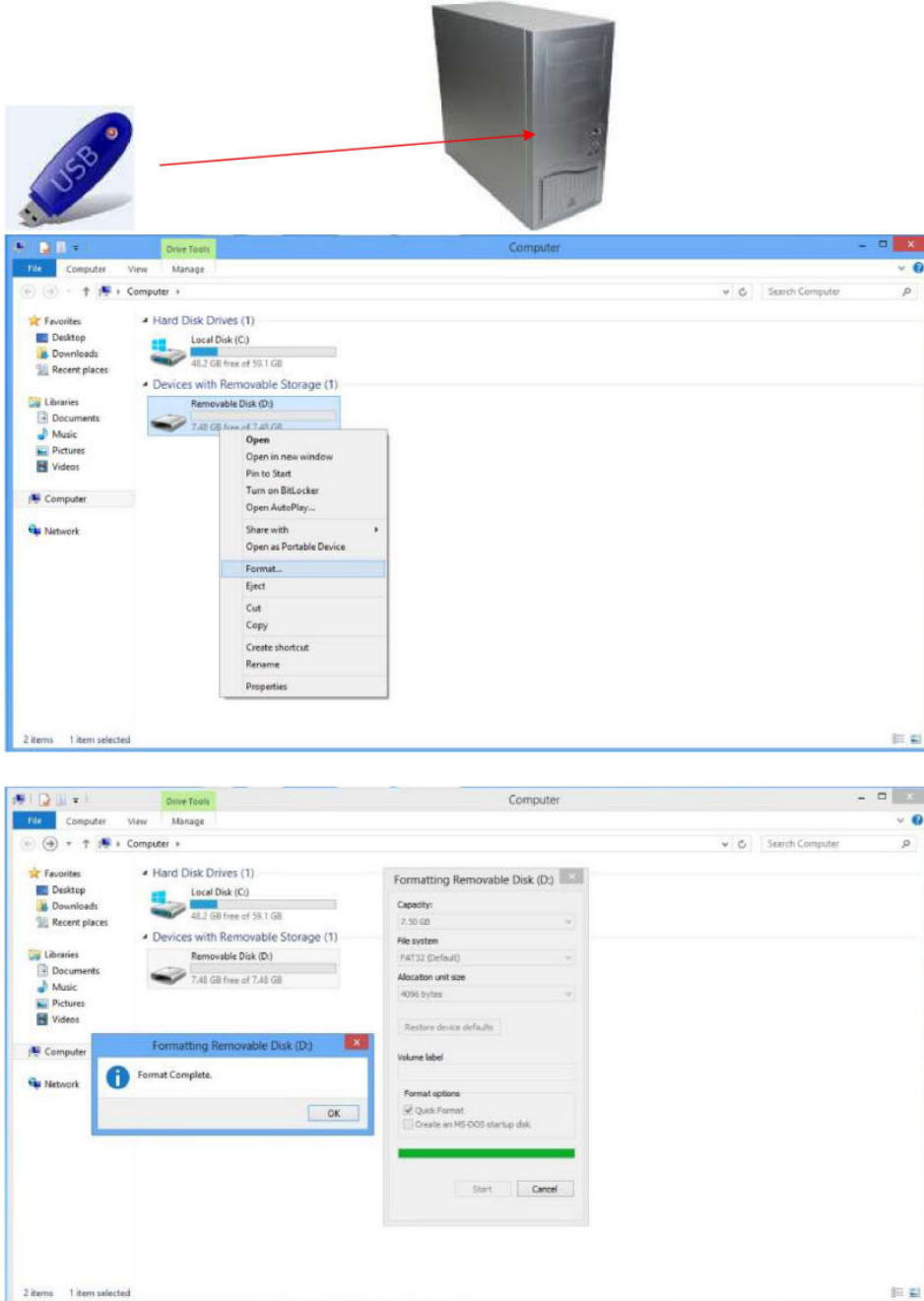

2. Unzip files from **BIOS update zipped file for UEFI**, and place all files into a folder named **BIOS_Update** into the USB drive.
Note: The actual files listed in the screenshot below may be different.

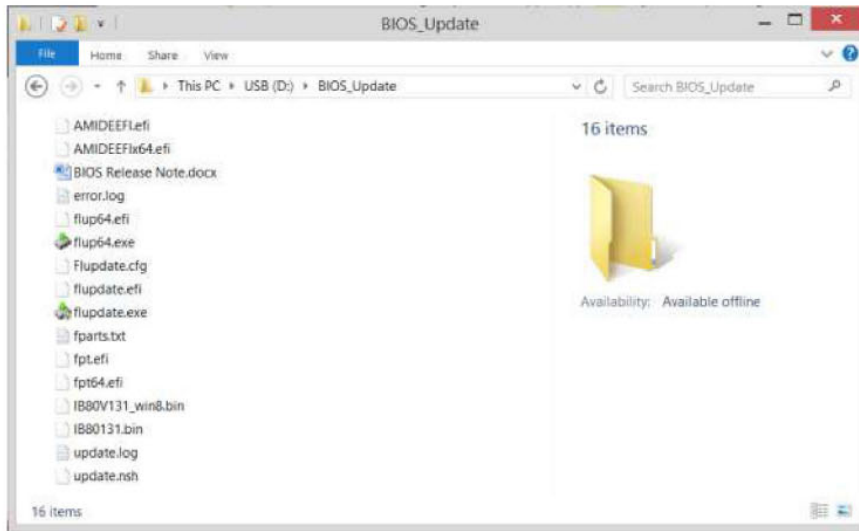
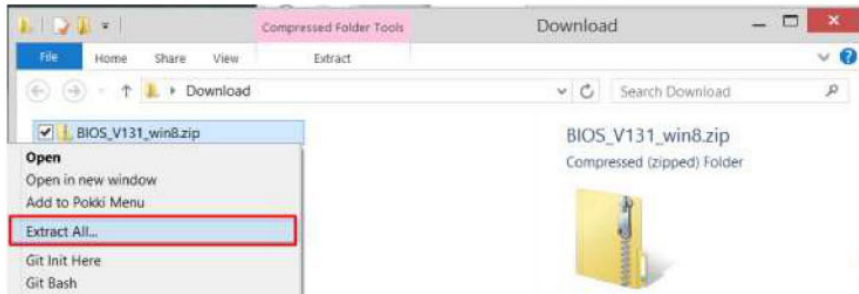

3. The USB drive is now ready to be used to perform for BIOS and EC firmware update procedure detailed in the next section.

Update/Flash BIOS and EC under UEFI Shell Mode

1. Prepare the tablet to be updated by plugging in the **AC Adapter**, **USB hub**, the **update USB drive** (prepared in the previous section), **USB keyboard**.

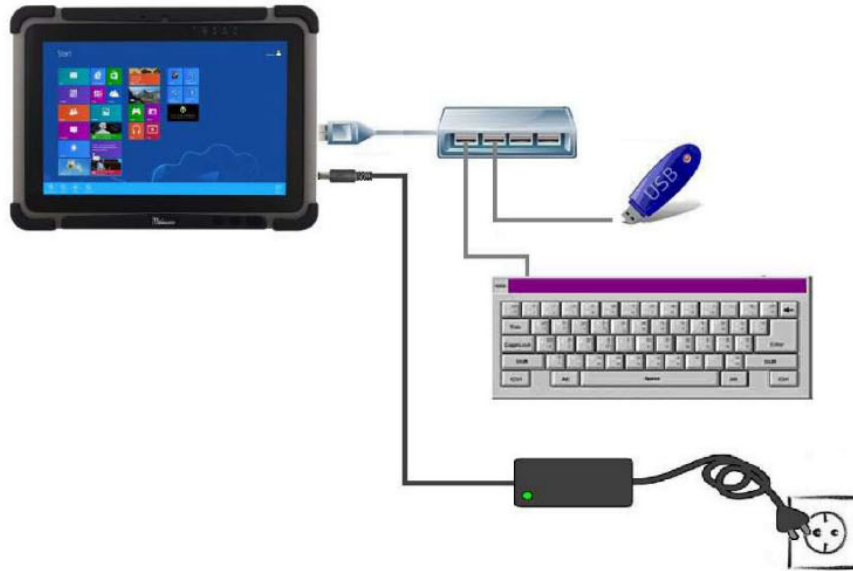

2. Power on the tablet while pressing **DEL** key on the keyboard. When prompted, enter the BIOS password to enter the **BIOS Setup Menu**.
3. Use the direction keys on the keyboard to navigate to the submenu **"Save & Exit"**, and then choose **"Launch EFI Shell from filesystem device"** by pressing **Enter**. Now the tablet will load into UEFI Shell mode, for user to enter the update command.

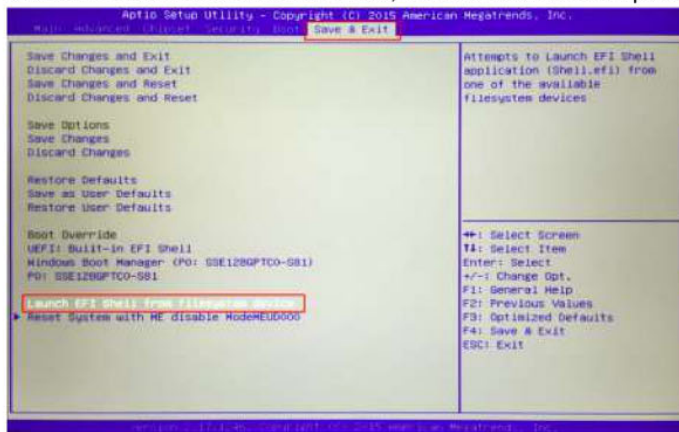

4. When the tablet goes into the **UEFI Shell mode**, it will automatically load and show on the screen the USB devices connected to the tablet, the users will see a list of USB devices, and their **designation**.

```
PciRoot (0x0)/Pci(0x13,0x0)/Sata(0x0,0x0)/HD(4,GPT,936501FC-2282-4245-AB1E-3AFD3AED78A8,0x16C800,0x1388000)
fs3 :HardDisk - Alias hd5a65535a5 blk3
PciRoot (0x0)/Pci(0x13,0x0)/Sata(0x0,0x0)/HD(5,GPT,C6CCE92A-7DA0-48AA-A1A7-C0F29ECA264C,0x14F4800,0xD987800)
fs4 :Removable HardDisk - Alias hd6b0e0b blk4
PciRoot (0x0)/Pci(0x14,0x0)/USB(0x1,0x0)/USB(0x4,0x0)/HD(1,MBR,0x00000000,0x800,0xEEF000)
blk0 :HardDisk - Alias hd5a65535a1 fs0
PciRoot (0x0)/Pci(0x13,0x0)/Sata(0x0,0x0)/HD(1,GPT,8A66F8C6-D757-47F3-8097-6E4F0B461A89,0x800,0x32000)
blk1 :HardDisk - Alias hd5a65535a3 fs1
PciRoot (0x0)/Pci(0x13,0x0)/Sata(0x0,0x0)/HD(3,GPT,F6E1D459-6D04-4871-9340-442480AA7391,0x72B00,0xFA000)
blk2 :HardDisk - Alias hd5a65535a4 fs2
PciRoot (0x0)/Pci(0x13,0x0)/Sata(0x0,0x0)/HD(4,GPT,936501FC-2282-4245-AB1E-3AFD3AED78A8,0x16C800,0x1388000)
blk3 :HardDisk - Alias hd5a65535a5 fs3
PciRoot (0x0)/Pci(0x13,0x0)/Sata(0x0,0x0)/HD(5,GPT,C6CCE92A-7DA0-48AA-A1A7-C0F29ECA264C,0x14F4800,0xD987800)
blk4 :Removable HardDisk - Alias hd6b0e0b fs4
PciRoot (0x0)/Pci(0x14,0x0)/USB(0x1,0x0)/USB(0x4,0x0)/HD(1,MBR,0x00000000,0x800,0xEEF000)
blk5 :HardDisk - Alias (null)
PciRoot (0x0)/Pci(0x13,0x0)/Sata(0x0,0x0)/HD(2,GPT,E35A3680-B5E3-4F06-B263-800641DA54A8,0x32B00,0x40000)
blk6 :BlockDevice - Alias (null)
PciRoot (0x0)/Pci(0x13,0x0)/Sata(0x0,0x0)
blk7 :Removable BlockDevice - Alias (null)
PciRoot (0x0)/Pci(0x14,0x0)/USB(0x1,0x0)/USB(0x4,0x0)

Press ESC in 1 seconds to skip startup.nsh, any other key to continue.
Shell> _
```

- From the list of USB devices, find the device shown as **Removable HardDisk**, and identify its **designation** (i.e. "fs4"). Please note this **designation** may be different from the user's own session, so please take note and identify it as it will be used as a command.

Notes:

*If **Removable HardDisk** is not shown as a loaded device on screen, please restart the tablet and start from Step 2 of this guide.*

*If multiple instances of the **Removable HardDisk** are present, please retry steps 5 to 7 using a different designation until the USB drive's directory prompt is received. Note that fs4 is shown in picture as reference only.*

```
PciRoot (0x0)/Pci(0x13,0x0)/Sata(0x0,0x0)/HD(4,GPT,936501FC-2282-4245-AB1E-3AFD3AED78A8,0x16C800,0x1388000)
fs3 :HardDisk - Alias hd5a65535a5 blk3
PciRoot (0x0)/Pci(0x13,0x0)/Sata(0x0,0x0)/HD(5,GPT,C6CCE92A-7DA0-48AA-A1A7-C0F29ECA264C,0x14F4800,0xD987800)
fs4 :Removable HardDisk - Alias hd6b0e0b blk4
PciRoot (0x0)/Pci(0x14,0x0)/USB(0x1,0x0)/USB(0x4,0x0)/HD(1,MBR,0x00000000,0x800,0xEEF000)
blk0 :HardDisk - Alias hd5a65535a1 fs0
PciRoot (0x0)/Pci(0x13,0x0)/Sata(0x0,0x0)/HD(1,GPT,8A66F8C6-D757-47F3-8097-6E4F0B461A89,0x800,0x32000)
```

6. Enter the Removable HardDisk's **designation** (i.e. "fs4") into the command prompt, and follow by a **colon sign** (":"), and press **Enter**, to browse into the update USB drive. The full command shall be as shown below.

```
Press ESC in 1 seconds to skip startup.nsh,
Shell> fs4: _
```

7. Once in the USB drive's directory, enter the command "cd BIOS_Update" to browse into the folder with update files.

```
fs4:\> cd BIOS_Update
```

8. Once in the BIOS_Update directory, enter command "update" and press **Enter** to start the script to run the BIOS update procedure.

```
fs4:\BIOS_Update> update.
```

9. The update script will scan through the BIOS on the tablet and replace it with a new BIOS. The user will see block of data being programmed with percentages.

Warning: Please do not unplug the AC Adapter, the update USB, or shutdown the tablet during this update, as it may cause permanent damage to the tablet that may require substantial hardware repair.

```
Copyright (c) 2007 - 2013, Intel Corporation. All Rights reserved.
Platform: Bay Trail
SpiLoadDevicesFile(fparts.txt)...
Reading HSFSTS register... Flash Descriptor: Valid

--- Flash Devices Found ---
W25Q64DW ID:0xEF6017 Size: 8192KB (65536kb)

PDR Region does not exist.

- Reading Flash [0x800000] 8192KB of 8192KB - 100% complete.
- Erasing Flash Block [0x005000] - 100% complete.
- Programming Flash [0x005000] 4KB of 4KB - 100% complete.
- Erasing Flash Block [0x008000] - 100% complete.
- Programming Flash [0x008000] 12KB of 12KB - 100% complete.
- Erasing Flash Block [0x32F000] - 100% complete.
- Programming Flash [0x32F000] 188KB of 188KB - 100% complete.
- Erasing Flash Block [0x340000] - 100% complete.
- Programming Flash [0x340000] 4KB of 4KB - 100% complete.
- Erasing Flash Block [0x36A000] - 100% complete.
- Programming Flash [0x36A000] 104KB of 104KB - 100% complete.
- Erasing Flash Block [0x50C000] - 100% complete.
- Programming Flash [0x50C000] 2288KB of 2288KB - 100% complete.
- Erasing Flash Block [0x75B000] - 100% complete.
- Programming Flash [0x75B000] 196KB of 196KB - 100% complete.
- Erasing Flash Block [0x7CB000] - 100% complete.
- Programming Flash [0x7CB000] 140KB of 140KB - 100% complete.
- Erasing Flash Block [0x800000] - 100% complete.
- Programming Flash [0x800000] 4KB of 4KB - 100% complete.
- Verifying Flash [0x2CC000] 2867KB of 8192KB - 35% complete.
```

10. Once the BIOS update is done, a **FPT Operation Passed** message will be shown, and the update script will automatically bring up the EC firmware update program. The user will need to enter “Y” on the keyboard to initiate the EC firmware update.

```

- Erasing Flash Block [0x50C000] - 100% complete.
- Programming Flash [0x50C000] 2288KB of 2288KB - 100% complete.
- Erasing Flash Block [0x75B000] - 100% complete.
- Programming Flash [0x75B000] 196KB of 196KB - 100% complete.
- Erasing Flash Block [0x7CB000] - 100% complete.
- Programming Flash [0x7CB000] 140KB of 140KB - 100% complete.
- Erasing Flash Block [0x800000] - 100% complete.
- Programming Flash [0x800000] 4KB of 4KB - 100% complete.
- Verifying Flash [0x800000] 8192KB of 8192KB - 100% complete.
RESULT: The data is identical.

FPT Operation Passed

update> AMIDEFIx64.efi /su auto
-----
| AMIDEFIx64 Utility (Aptio) v5.13.1 |
| Copyright (C)2013 American Megatrends Inc. All Rights Reserved. |
-----

Initializing the SMBIOS interface. Please wait a moment.....
Name R/W Status Information
-----
(/SU)System UUID M Done "00F9752A58BE4119E4C60DC32B16500"
update> flup64.efi -nocomp -noverify -novr -v -rfp -x 1 IB80131.bin
Welcome to Flash Update Application
Please wait a few seconds while loading the configuration
and binary image files.
Flash Update Process is Ready To Begin
Do you want to start the download process?
Y = Yes N = No

```

11. Once the EC firmware update starts, a percentage will be shown for current progress. At the end of the EC firmware update procedure, the user should see the **percentage completed** at 100%. The tablet will restart automatically at completion.
Warning: Please do not unplug the AC Adapter, the update USB, or shutdown the tablet during this update, as it may cause permanent damage to the tablet that may require substantial hardware repair.

```

- Programming Flash [0x320000] 4KB of 4KB - 100% complete.
- Verifying Flash [0x800000] 8192KB of 8192KB - 100% complete.
RESULT: The data is identical.

FPT Operation Passed

update> AMIDEFIx64.efi /su auto
-----
| AMIDEFIx64 Utility (Aptio) v5.13.1 |
| Copyright (C)2013 American Megatrends Inc. All Rights Reserved. |
-----

Initializing the SMBIOS interface. Please wait a moment.....
Name R/W Status Information
-----
(/SU)System UUID M Done "00C77E165CEBE41183397EB689A62400"
update> flup64.efi -nocomp -noverify -novr -v -rfp -x 1 IB80131.bin
Welcome to Flash Update Application
Please wait a few seconds while loading the configuration
and binary image files.
Flash Update Process is Ready To Begin
Do you want to start the download process?
Y = Yes N = No
uFlash Update Process is Ready To Begin
Please wait a few seconds while performing calculations...
Reading Calibration values...
Download in Progress
Warning: Do not restart or shutdown the computer while
downloading to flash.
Percentage completed: [.....] 100%

```

12. Now the BIOS/EC update process should be completed.
13. During the BIOS/EC update process, the serial number of the device is actually saved onto the USB drive used for BIOS update. To reload the serial number of the device back into the device after BIOS/EC update, please proceed with the next section "Reload Serial Number under UEFI Shell Mode".

Reload Serial Number under UEFI Shell Mode

Note: For the serial number reloading, please perform this process right after the BIOS/EC update, and please use the same USB drive used during the BIOS/EC update process, as the serial number of the device actually temporality captured and saved on the USB drive. If this serial number reloading process is not followed right after BIOS/EC update, then the serial number may be lost.

1. Ensure that the unit is powered-off. Hold the power button for more than 6 seconds until the unit turns-off. Then, power on the tablet while pressing **DEL** key on the keyboard. When prompted, enter the BIOS password to enter the **BIOS Setup Menu**.
2. Use the direction keys on the keyboard to navigate to the submenu "**Save & Exit**", and then choose "**Launch EFI Shell from filesystem device**" by pressing **Enter**. Now the tablet will load into UEFI Shell mode, for user to enter the update command.

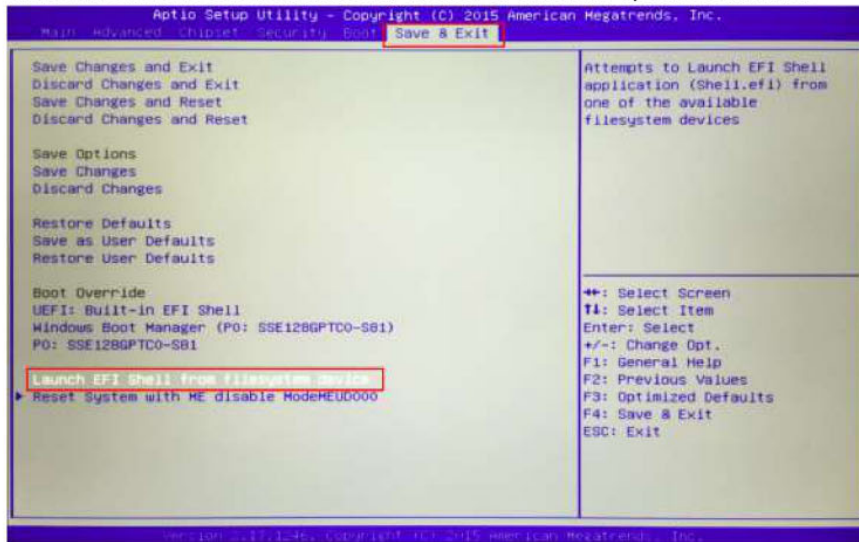

3. When the tablet goes into the **UEFI Shell mode**, it will automatically load and show on the screen the USB devices connected to the tablet, the users will see a list of USB devices, and their **designation**.

```
PciRoot (0x0)/Pci(0x13,0x0)/Sata(0x0,0x0)/HD(4,GPT,936501FC-2282-4245-AB1E-3AFD3AED78A8,0x16C800,0x1388000)
fs3 :HardDisk - Alias hd5a65535a5 blk3
PciRoot (0x0)/Pci(0x13,0x0)/Sata(0x0,0x0)/HD(5,GPT,C6CCE92A-7DA0-48AA-A1A7-C0F29ECA264C,0x14F4800,0xD987800)
fs4 :Removable HardDisk - Alias hd6b0e0b blk4
PciRoot (0x0)/Pci(0x14,0x0)/USB(0x1,0x0)/USB(0x4,0x0)/HD(1,MBR,0x00000000,0x800,0xEEF000)
blk0 :HardDisk - Alias hd5a65535a1 fs0
PciRoot (0x0)/Pci(0x13,0x0)/Sata(0x0,0x0)/HD(1,GPT,8A66F8C6-D757-47F3-8097-6E4F0B461A89,0x800,0x32000)
blk1 :HardDisk - Alias hd5a65535a3 fs1
PciRoot (0x0)/Pci(0x13,0x0)/Sata(0x0,0x0)/HD(3,GPT,F6E1D459-6D04-4871-9340-442480AA7391,0x72B00,0xFA000)
blk2 :HardDisk - Alias hd5a65535a4 fs2
PciRoot (0x0)/Pci(0x13,0x0)/Sata(0x0,0x0)/HD(4,GPT,936501FC-2282-4245-AB1E-3AFD3AED78A8,0x16C800,0x1388000)
blk3 :HardDisk - Alias hd5a65535a5 fs3
PciRoot (0x0)/Pci(0x13,0x0)/Sata(0x0,0x0)/HD(5,GPT,C6CCE92A-7DA0-48AA-A1A7-C0F29ECA264C,0x14F4800,0xD987800)
blk4 :Removable HardDisk - Alias hd6b0e0b fs4
PciRoot (0x0)/Pci(0x14,0x0)/USB(0x1,0x0)/USB(0x4,0x0)/HD(1,MBR,0x00000000,0x800,0xEEF000)
blk5 :HardDisk - Alias (null)
PciRoot (0x0)/Pci(0x13,0x0)/Sata(0x0,0x0)/HD(2,GPT,E35A3680-B5E3-4F06-B263-800641DA54AB,0x32B00,0x40000)
blk6 :BlockDevice - Alias (null)
PciRoot (0x0)/Pci(0x13,0x0)/Sata(0x0,0x0)
blk7 :Removable BlockDevice - Alias (null)
PciRoot (0x0)/Pci(0x14,0x0)/USB(0x1,0x0)/USB(0x4,0x0)

Press ESC in 1 seconds to skip startup.nsh, any other key to continue.
Shell> _
```

- From the list of USB devices, find the device shown as **Removable HardDisk**, and identify its **designation** (i.e. “fs4”). Please note this **designation** may be different from the user’s own session, so please take note and identify it as it will be used as a command.

Notes:

*If **Removable HardDisk** is not shown as a loaded device on screen, please restart the tablet and start from Step 2 of this guide.*

*If multiple instances of the **Removable HardDisk** are present, please retry steps 4 to 6 using a different designation until the USB drive’s directory prompt is received. Note that fs4 is shown in picture as reference only.*

```
PciRoot (0x0)/Pci(0x13,0x0)/Sata(0x0,0x0)/HD(4,GPT,936501FC-2282-4245-AB1E-3AFD3AED78A8,0x16C800,0x1388000)
fs3 :HardDisk - Alias hd5a65535a5 blk3
PciRoot (0x0)/Pci(0x13,0x0)/Sata(0x0,0x0)/HD(5,GPT,C6CCE92A-7DA0-48AA-A1A7-C0F29ECA264C,0x14F4800,0xD987800)
fs4 :Removable HardDisk - Alias hd6b0e0b blk4
PciRoot (0x0)/Pci(0x14,0x0)/USB(0x1,0x0)/USB(0x4,0x0)/HD(1,MBR,0x00000000,0x800,0xEEF000)
blk0 :HardDisk - Alias hd5a65535a1 fs0
PciRoot (0x0)/Pci(0x13,0x0)/Sata(0x0,0x0)/HD(1,GPT,8A66F8C6-D757-47F3-8097-6E4F0B461A89,0x800,0x32000)
```

- Enter the Removable HardDisk’s **designation** (i.e. “fs4”) into the command prompt, and follow by a **colon sign** (“:”), and press **Enter**, to browse into the update USB drive. The full command shall be as shown below.

```
Press ESC in 1 seconds to skip startup.nsh,
Shell> fs4:_
```

- Once in the USB drive's directory, enter the command "**cd BIOS_Update**" to browse into the folder with update files.

```
fs4:\> cd BIOS_Update
```

- Once in the USB drive's directory, enter the command "**smbios**" and press **Enter** to start the script to reload the Serial Number back into the device.

```
fs4:\BIOS_Update> smbios.nsh_
```

- The **smbios** script will reload the serial number back into the device.
- After successful serial number reloading, the temporality saved serial number on the USB Drive will then be removed automatically. Enter the command "**exit**" and press **Enter** to return to the **BIOS Setup Menu**. From the "**Save & Exit**" submenu, choose "**Discard Changes and Exit**" and press **Enter**. Select "**Yes**" and press "**Enter**". The tablet will restart.
- Finally, to ensure the BIOS and EC firmware updates are applied successfully, from **Windows**, please restart the tablet and press the **DEL** on the keyboard while the tablet is starting up. When prompted, enter the BIOS password to boot into **BIOS Setup Menu**.
- Once the **BIOS Setup Menu** starts, check under the "**Main**" menu to find the **Project Version** and the **EC Version** that shows that the update was successfully applied. Note that the picture below is added as reference only to show the location where to find the EC Version.

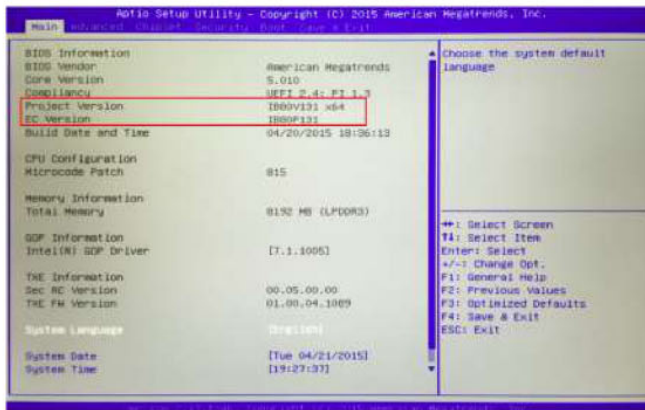

- From the "**Save & Exit**" submenu, choose "**Discard Changes and Exit**" and press **Enter**. Select "**Yes**" and press "**Enter**". The tablet will restart.